

INTERNATIONAL AEROBATIC CLUB SCORESHEET

A

Contest:

SM2019 Malmi

Date:

2019

Category:

Sportsman

Programme:

Known

pilot's

number

--

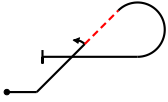
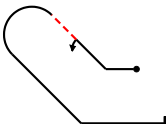
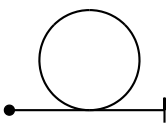
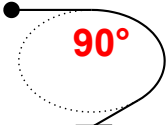
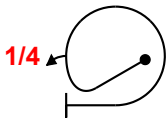
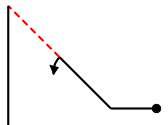
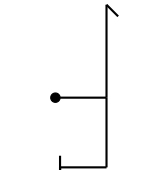
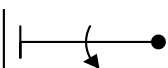
No	Symbol	Cat. No.	K	Total K	Grade	Remarks	Item	K	Score						
1		8.5.2.1 9.1.2.2	10 9	19			Presentation 15 FIGURE TOTAL K = 121 INC. PRESENTATION = 136 Aircraft type: FREE PROGRAM CHECKED BY: <table border="1" style="width: 100%; border-collapse: collapse; margin-top: 10px;"> <tr> <td style="width: 30%; height: 100px; vertical-align: bottom;">Signature:</td> <td style="width: 30%; height: 100px; vertical-align: bottom;">Printed Name:</td> <td style="width: 40%; height: 100px; vertical-align: bottom;">Date:</td> </tr> <tr> <td style="width: 30%; height: 100px; vertical-align: bottom;">IAC No:</td> <td colspan="2"></td> </tr> </table> Judge Name: IAC # Assistant Name: IAC #	Signature:	Printed Name:	Date:	IAC No:				
Signature:	Printed Name:	Date:													
IAC No:															
2		8.4.15.1 9.1.2.2	12 9	21											
3		7.4.1.1	10	10											
4		2.1.1.1	3	3											
5		0.1	16	16											
6		1.2.3.1 9.1.2.2	12 9	21											
7		5.2.1.1	17	17											
8		1.1.1.1 9.1.3.4	2 12	14											



Pilot

A/C



B	Contest:	SM2019 Malmi	Category:	Sportsman
	Date:	2019	Program:	Known
			Pilot's No.	<input type="text"/>

Pilot:

wind direction

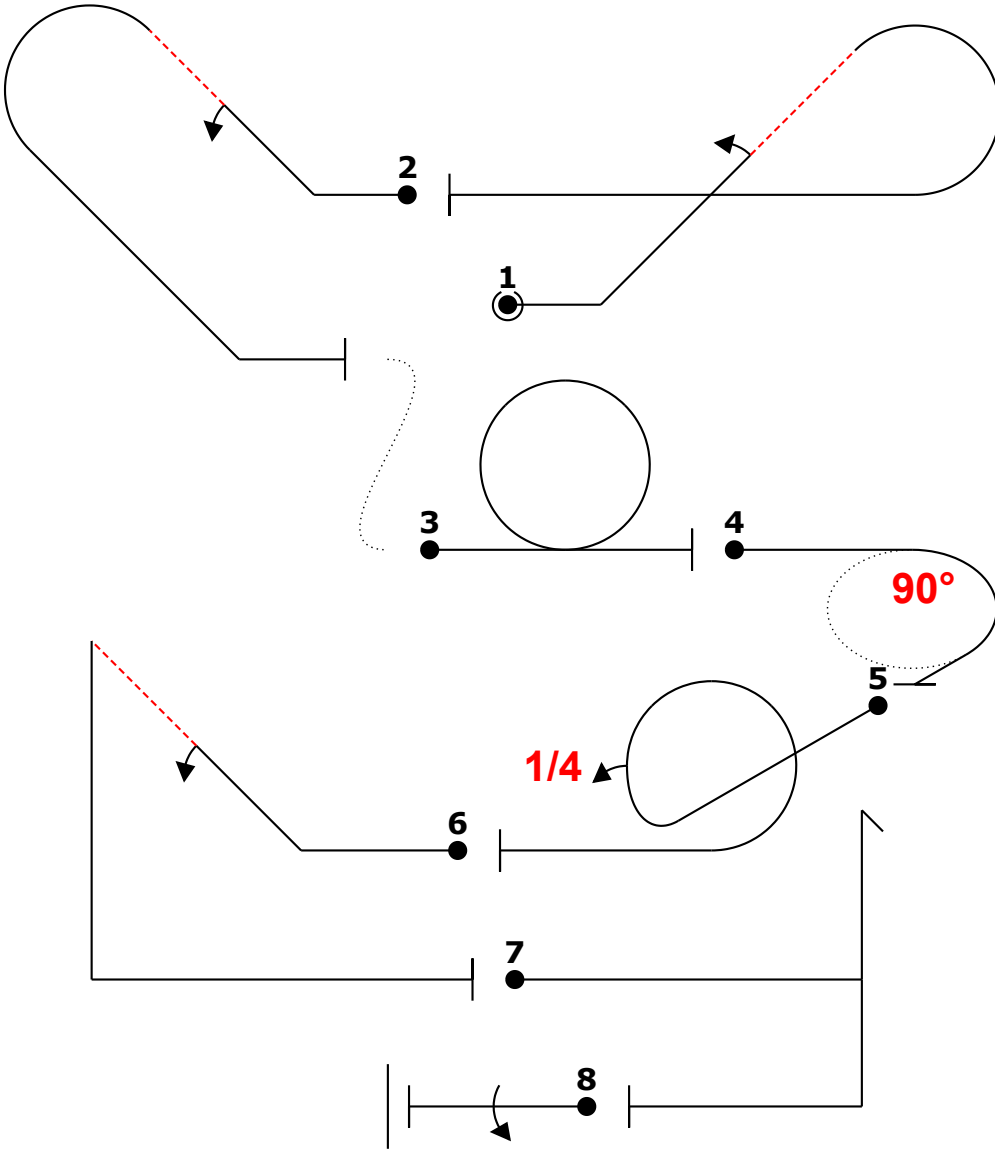

Glider			
Fig	Aresti	K	
1	8.5.2.1 9.1.2.2	10 9	19
2	8.4.15.1 9.1.2.2	12 9	21
3	7.4.1.1	10	10
4	2.1.1.1	3	3
5	0.1	16	16
6	1.2.3.1 9.1.2.2	12 9	21
7	5.2.1.1	17	17
8	1.1.1.1 9.1.3.4	2 12	14
Total K = 121			

A/C:

(signature/date)

FREE PROGRAM CHECK BY:



C	Contest:	SM2019 Malmi	Category:	Sportsman
	Date:	2019	Program:	Known
			Pilot's No.	<input type="text"/>

Pilot:

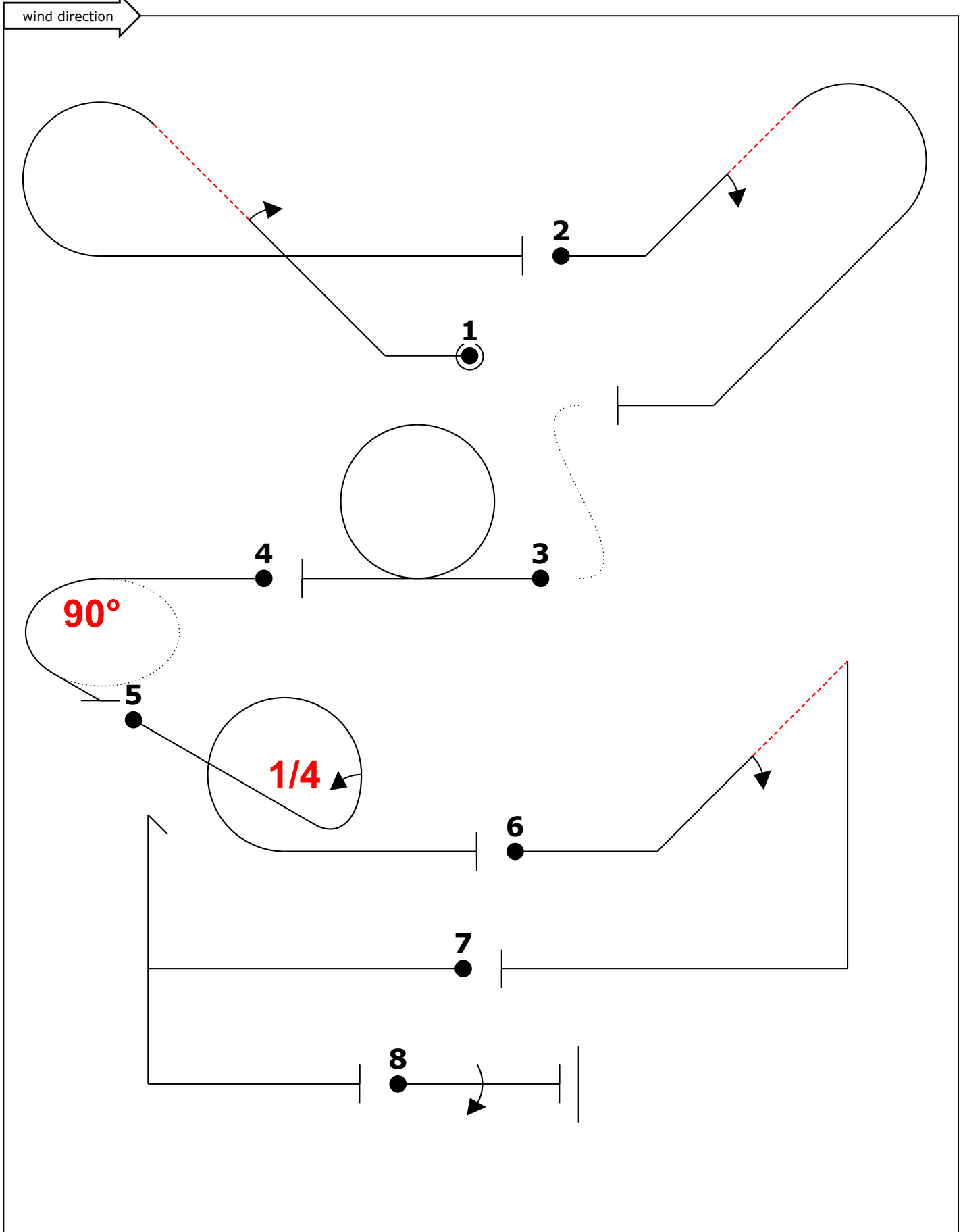

A/C:

(signature/date)

FREE PROGRAM CHECK BY: